

SIMPLE INTERACTIVE NOZZLES

Non-Sequencing/Constant Flow

While choreographed water features can be exciting, similar effects can be achieved using non-sequenced nozzles. These constant flow nozzles don't require computer controls, simply turn the pump "on" and the fountain is in operation!

Fountains designed for public play require certain design features:

- Flush mounted (no trip hazards)
- Deck-friendly (no toe entrapment)
- Play-safe (soft water)
- Some smaller nozzles require lower GPM and can be supplied by municipal water supplies.

76	SIMPLE INTERACTIVE DECK JETS
77	AJD Series – Drain with Center Jet
78	NLG Series – Ground Jet
80	NLC Series – Column Jet
81	NCB Series – Deck Level Cascade Niche
82	NSS Series – Deck Level Spray Ring
83	NLH Series – Bi-Stream Ground Jet
84	NLF Series – Deck Level Crown Jet
85	Introduction to Illuminated Deck Jets
86	LED 170 Series – Illuminated Ground Jet
90	NNC Series – Dynamite Blast/V-Blast
92	More Simple Interactive Deck Jets

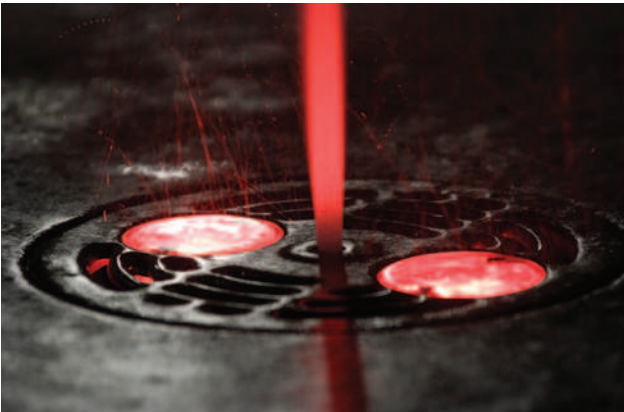
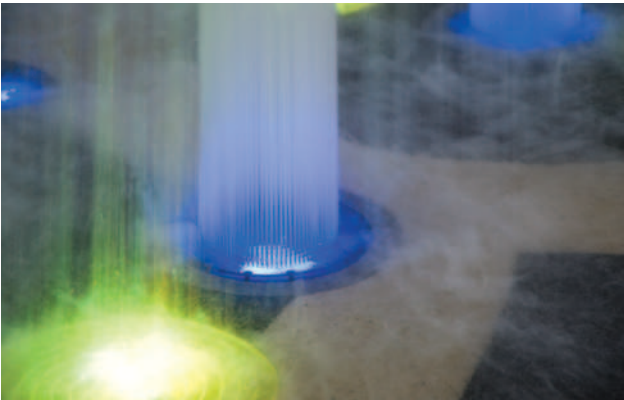

AJD Series – Drain with Center Jet

Primarily used in spray aprons for public playgrounds. This flush-mounted effect provides a cost effective solution that's both functional and decorative. The 102mm side outlet connects to a drain line. Water source is plumbed within drain piping. Made of machined cast bronze, brass and stainless steel fitted.

*For interactive play, do not exceed 6m per second.

VISIBILITY	■ ■ ■ □ □
SOUND LEVEL	■ ■ □ □ □
WIND RESISTANCE	■ □ □ □ □
SPLASH/MIST	■ ■ ■ ■ □
EFFICIENCY	■ ■ □ □ □

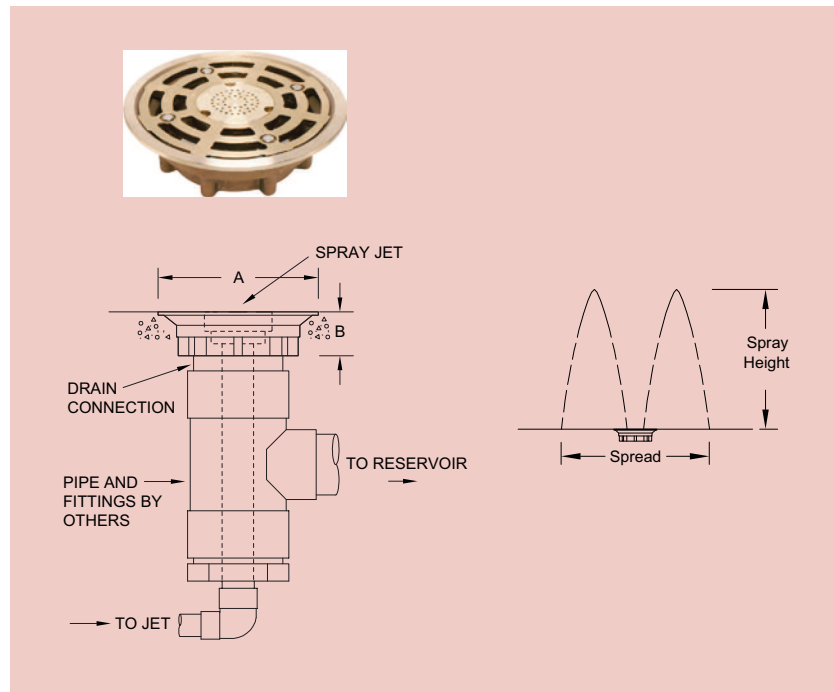

**Contact Crystal Fountains for detailed specifications, installation and operation details.*

DIMENSIONS

Part No.	Inlet (b.s.p.t.)	Drain Connection (mm)	a dim. (mm)	b dim. (mm)	Suction Strainer Openings (mm)
AJD100	1 1/4"	153	305	89	2

PERFORMANCE

Spray height (m.)	0.6	1	1.3	1.6	1.9
LPM	15.0	19.0	23.0	26.0	26.0
Head (m.)	1	1.6	1.9	2.5	3.1
Spread (cm.)	41	56	82	92	112

NLG Series – Ground Jet

A popular, multi-purpose spray jet that can be used in small and medium-sized playdecks*. Big brother to the NLF (Crown Jet), this nozzle is 127mm diameter and creates a larger volume of gentle spray. Available with 4 interchangeable tops for different spray patterns that provide up to 5m of spread. Made of machined cast bronze with removable faceplate for easy cleaning with an optional security key. Optional alignment swivel available (ASU). Optional winter cover also available. **Not water level dependent.**



*For interactive play, do not exceed 6 meters per second.

VISIBILITY	■ ■ ■ □ □
SOUND LEVEL	■ ■ □ □ □
WIND RESISTANCE	■ □ □ □ □
SPLASH/MIST	■ ■ ■ ■ □
EFFICIENCY	■ ■ □ □ □



NLG200

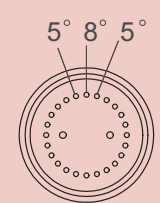

NLG200



NLG201

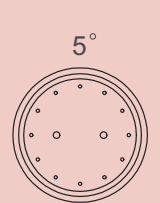

NLG201



NLG202

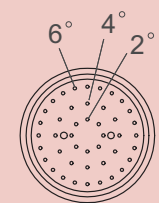

NLG202



NLG203

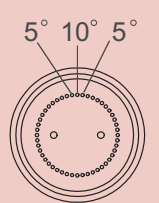

NLG203

NLG Series – Ground Jet



**Contact Crystal Fountains for detailed specifications, installation and operation details.*

DIMENSIONS

PERFORMANCE

Part No.	Inlet (b.s.p.t.)	a dim. (mm)	b dim. (mm)	Suction Strainer Openings max. mm.	Spray height (m.)			
					1	1.6	3.1	
NLG200	2"	77	127	1	LPM	114.0	148.0	220.0
					Head (m.)	1.6	2.5	5.5
					Spread (cm.)	122	183	336
NLG201	2"	77	127	1	LPM	98.0	129.0	189.0
					Head (m.)	1.6	2.5	4.9
					Spread (cm.)	7	12	21
NLG202	2"	77	127	1	LPM	95.0	121.0	178.0
					Head (m.)	1.6	2.5	5.2
					Spread (cm.)	92	138	244
NLG203	2"	77	127	1	LPM	98.0	129.0	182.0
					Head (m.)	1.6	2.5	4.6
					Spread (cm.)	138	206	336

Options Add Suffix

Security Key K

Winter Cover W

NLC Series – Column Jet

A simple, vertical column of clear water ideal as a focal point for small and medium-sized displays. Composed of an array of smaller openings to create a delicate upward spray. Also appropriate as a secondary effect for large displays. Optional alignment swivel available (ASU). Made of machined bronze and brass with removable top for easy cleaning. **Not water level dependent.**

*For interactive play, do not exceed 6 meters per second.



<p>VISIBILITY ■ ■ ■ ■ □</p> <p>SOUND LEVEL ■ ■ □ □ □</p> <p>WIND RESISTANCE ■ ■ ■ ■ □</p> <p>SPLASH/MIST ■ ■ ■ □ □</p> <p>EFFICIENCY ■ ■ □ □ □</p>			
---	--	--	--

**Contact Crystal Fountains for detailed specifications, installation and operation details.*

DIMENSIONS

Part No.	Inlet (n.p.t.) (mm)	a dim. (mm)	b dim. (mm)	w dim. (mm)	Suction Strainer Openings max. mm.
NLC075	1"	51	64	51	2

PERFORMANCE

Spray height (m.)	0.6	1	1.3	1.6	1.9
LPM	38.0	45.0	53.0	57.0	60.0
Head (m.)	1.3	1.9	2.5	2.8	3.4
Spread (cm.)	21	26	26	31	31

Options	Add Suffix
Cover Removal Key	K
Winter Cover	W

NCB Series – Deck Level Cascade Niche

The Deck level Cascade Niche is specifically designed for dry or poured deck concrete fountains and is ideal for a main feature or for soft, interactive play*. The easy to maintain package incorporates the cascade nozzle and water level inlet piping to create the popular pyramid shaped mound of water. Niche is pre-plumbed for easy installation and comes with an integrated overflow adjustment valve. Also comes with a stainless steel cover and central stainless steel mesh for water flow and safety. Available with optional stainless steel winter cover, and tamperproof screwdriver. Made of bronze and stainless steel. Water level dependent.

*For interactive play, do not exceed 6 m per second.



VISIBILITY	■ ■ ■ ■ ■
SOUND LEVEL	■ ■ ■ □ □
WIND RESISTANCE	■ ■ ■ ■ ■
SPLASH/MIST	■ ■ ■ □ □
EFFICIENCY	■ ■ □ □ □

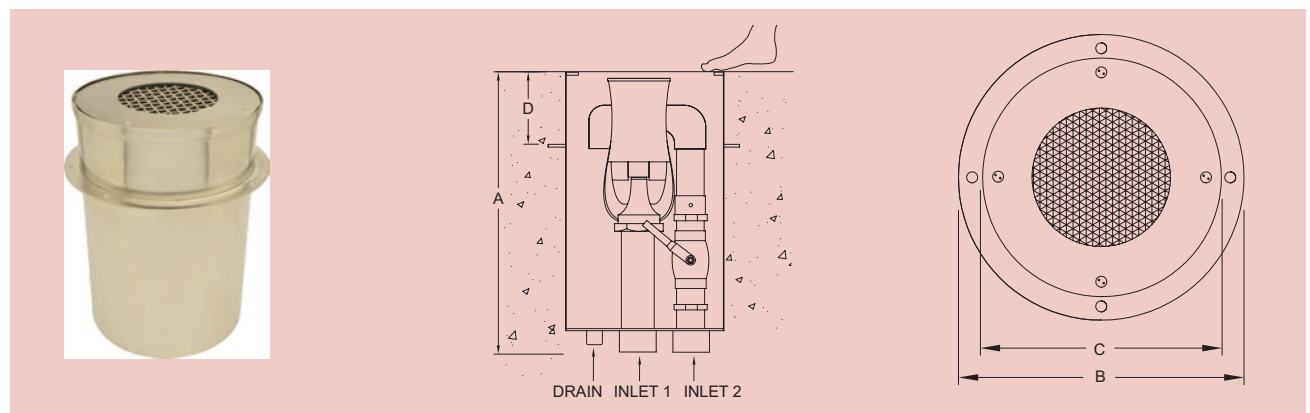

DIMENSIONS

Part No.	Inlet 1 (b.s.p.t.)	Inlet 2 (b.s.p.t.)	Drain Connection (mm)	a dim. (mm)	b dim. (mm)	c dim. (mm)	d dim. (mm)
NCB200	2"	2"	13	432	331	280	112

PERFORMANCE

Spray height (m.)	1.3	1.6	1.9	2.5
Inlet 1 LPM	159.0	178.0	189.5	231.0
Inlet 2 LPM	159.0	178.0	189.5	231.0
Head (m.)	5.5	7.1	9.8	11.3
Spread (m.)	N/A	N/A	N/A	N/A

NSS Series – Deck Level Spray Ring

The Deck Level Spray Ring provides a classic look but is completely safe for interactive play. A range of 24 – 84 individual machined brass nozzles are placed in a circular pattern of between 0.6 m – 2.4 m in diameter. Custom sizes are also available upon request. Nozzle patterns create a lacy spray by day and sparkles when illuminated at night. Finishing of the spray ring is flush to the concrete making it ideal for interactive play*. Made of plastic and machined brass. Not water level dependent.

*For interactive play, do not exceed 6 m per second.



- VISIBILITY ■ ■ ■ ■ □
- SOUND LEVEL ■ ■ ■ ■ □
- WIND RESISTANCE ■ ■ □ □ □
- SPLASH/MIST ■ ■ ■ ■ □
- EFFICIENCY ■ ■ □ □ □

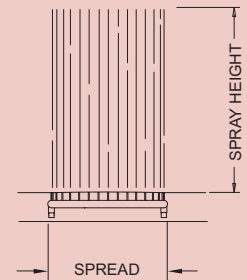
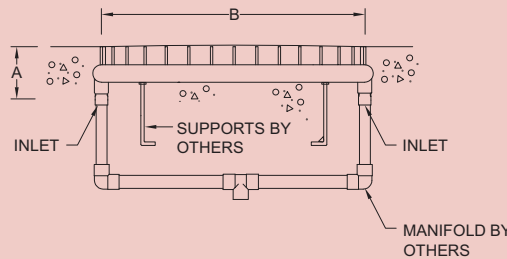

DIMENSIONS

PERFORMANCE

Part No.	Inlet (b.s.p.t.)	a dim. (mm)	b dim. (mm)	No. of Jets	Pipe Diameter (mm)	Suction Strainer Openings max. mm.	Spray height (m.)										
							0.6	1	1.3	1.6	1.9	2.5	3.1	3.7	4.3		
							Head (m.)	1.8	2.4	3	3.6	4.6	6.1	7.6	9.1	10.7	
Nozzle Opening = 4.7 mm							LPM	95.0	133.0	182.0	197.0	209.0					
NSS200	1 1/4" x 2	432	610	24	51	3											
NSS300	1 1/4" x 2	432	915	36	51	3											
NSS400	1 1/2" x 2	432	1220	48	51	3											
NSS500	1 1/2" x 2	432	1525	60	51	3											
NSS600	1 1/2" x 3	432	1829	72	51	3											
NSS800	1 1/2" x 4	432	2134	84	64	3											

NLH Series – Bi-Stream Ground Jet

The Bi-Stream Ground Jet produces two streams of water that rises up to 1.2m in height and throw up to 3.6m. Face plate is removable for easy cleaning with an optional security key. A versatile effect, the Bi-Stream can be used in small and medium sized fountains and be installed in-ground or above water. Comes with optional winter cover and security key. Made of cast bronze. Not water level dependent.



VISIBILITY	■ ■ ■ ■ ■
SOUND LEVEL	■ ■ ■ □ □
WIND RESISTANCE	■ ■ ■ □ □
SPLASH/MIST	■ ■ ■ □ □
EFFICIENCY	■ ■ ■ □ □

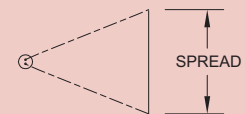
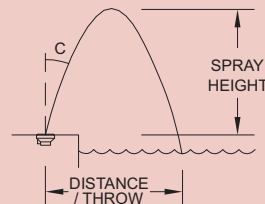
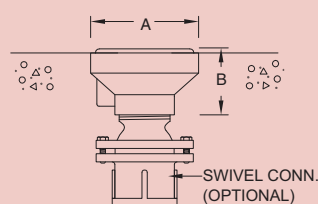

DIMENSIONS

Part No.	Inlet (b.s.p.t.)	a dim. (mm)	b dim. (mm)	Suction Strainer Openings max. mm.
NLH200	2"	77	127	1

PERFORMANCE

Throw (m.)	1.6	3.1	3.7
LPM	29.0	42.0	57.0
Head (m.)	1.3	2.5	3.2
Height (m.)	0.6	1.3	1.3
Spread (m.)	0.9	1.8	2.1

Options Add Suffix

Security Key	K
Winter Cover	W

NLF Series – Deck Level Crown Jet

A versatile, smaller jet that can be used on play decks providing gentle spray coverage and cooling. This effect creates a pretty, vertical tulip shape. Optional alignment swivel available (ASU). Made of machined cast bronze with removable, flush-mounted faceplate for easy cleaning with optional security key. Optional winter cover also available. Not water level dependent.

*For interactive play, do not exceed 6 m per second.

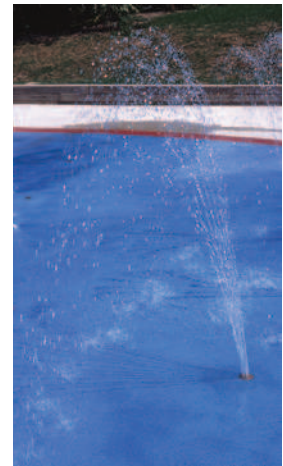

VISIBILITY	■ ■ ■ ■ □
SOUND LEVEL	■ □ □ □ □
WIND RESISTANCE	■ ■ ■ □ □
SPLASH/MIST	■ ■ ■ ■ ■
EFFICIENCY	■ ■ ■ □ □

SWIVEL CONN. (OPTIONAL)

NLF075

NLF075

NLF076

NLF076

NLF076

DIMENSIONS

Part No.	Inlet (b.s.p.t.)	a dim. (mm)	b dim. (mm)	Suction Strainer Openings max. mm.
NLF075	1"	64	51	2
NLF076	1"	64	51	2

PERFORMANCE

	0.6	1	1.3	1.9
Spray height (m.)				
LPM	15.0	19.0	23.0	26.0
Head (m.)	1	1.6	1.9	3.1
Spread (cm.)	45	60	90	120
Spray height (m.)				
LPM	19.0	19.0	23.0	34.0
Head (m.)	1.3	1.6	2.2	3.4
Spread (cm.)	106	168	230	360
Throw (m.)	0.6	1.3	1.3	2.2

Options	Add Suffix
Cover Removal Key	K
Winter Cover	W